

Original Instruction Manual

DX1000

Fine Filter 45 Litre Extractor

Version 3.1
January 2014



To register this product please visit
www.recordpower.info

It is important to register your product as soon as possible in order to receive efficient after sales support and be entitled to the full **5 year guarantee**. Your statutory rights are not affected.
Please see back cover for contact details.



Always wear safety glasses when using woodworking equipment.



Always read the instructions provided before using woodworking equipment.



Important

For your safety read instructions carefully before assembling or using this product.
Save this manual for future reference.







Contents

- 1. Explanation of Symbols**
 - 2. General Health & Safety Guidance**
 - 3. Additional Health & Safety Guidance for Dust Extractors**
 - 4. Record Power Guarantee**
 - 5. Specifications**
 - 6. Contents of the Package**
 - 7. Assembly & Operation**
 - 8. Electrical Connection & Wiring Diagram**
 - 9. Dust Extraction**
 - 10. Maintenance**
 - 11. Parts Diagram & List**
- EU Certificate of Conformity**





1. Explanation of Symbols

THE SYMBOLS AND THEIR MEANINGS SHOWN BELOW MAY BE USED THROUGHOUT THIS MANUAL. PLEASE ENSURE THAT YOU TAKE THE APPROPRIATE ACTION WHEREVER THE WARNINGS ARE USED.

Mandatory Instructions

-  Read and fully understand the instruction manual before attempting to use the machine.
-  Indicates an instruction that requires particular attention
-  Wear protective eyewear
-  Use respiratory protective equipment
-  Use hearing protection
-  Use suitable protective footwear
-  Use protective work gloves

Warning

-  Indicates a risk of severe personal injury or damage to the machine
-  Indicates a risk of severe personal injury from electrical shock
-  Risk of personal injury from lifting of heavy items
-  Indicates a risk of severe personal injury from airborne objects
-  Risk of fire

2. General Health & Safety Guidance

Ensure that you carefully read and fully understand the instructions in this manual before assembly, installation and use of this product. Keep these instructions in a safe place for future reference.

WARNING: for your own safety, do not attempt to operate this machine until it is completely assembled and installed according to these instructions.

WARNING: When using any machine, basic safety precautions should always be followed to reduce the risk of fire, electric shock and personal injury.

Safe Operation

1. Use Personal Protective Equipment (PPE)

- The operation of any machine can result in foreign objects being thrown into your eyes, which can result in severe eye damage. Protective eyewear or other suitable eye protection or face shield should be used at all times. Everyday spectacles only have impact resistant lenses. They are not protective eyewear and do not give additional lateral protection.
- Use respiratory protective equipment (dust mask etc.) if the machining operation creates dust. Exposure to high levels of dust created by machining hardwoods, softwoods and man made composite boards can result in serious health problems. Some imported hardwoods give off highly irritating dust, which can cause a burning sensation. The use of respiratory protective equipment should not be seen as an alternative to controlling the risk of exposure at source by using adequate dust extraction equipment.
- The use of ear plugs or ear defenders is recommended when the machine is in use, particularly if the noise level exceeds 85 dB.
- Wear suitable protective gloves when handling cutting tools or blades. Gloves should NOT be worn when using the machine as they can be caught in moving parts of the machine.
- Non-slip safety footwear is recommended when using the machine and handling large work pieces.

2. Dress appropriately

- Do not wear loose clothing, neckties or jewellery; they can be caught in moving parts of the machine.
- Roll up long sleeves above the elbow.
- Wear protective hair covering to contain long hair.

3. Safety warnings

- Find and read any warning labels on the machine.

- It is important that any labels bearing health and safety warnings are not removed, defaced or covered. Replacement labels can be obtained by contacting our Customer Service Department.

4. Familiarise yourself with the machine

- If you are not thoroughly familiar with the operation of this machine, obtain advice from your supervisor, instructor, or other qualified person or contact your retailer for information on training courses. Do not use this machine until adequate training has been undertaken.

5. Take care when moving or positioning the machine

- Some machines can be very heavy. Ensure the floor of the area in which the machine is to be used is capable of supporting the machine.
- The machine and its various components can be heavy. Always adopt a safe lifting technique and seek assistance when lifting heavy components. In some cases it may be necessary to use mechanical handling equipment to position the machine within the work area.
- Some machines have optional wheel kits available to allow them to be manoeuvred around the workshop as required. Care should be taken to install these according to the instructions provided.
- Due to the nature of the design of some machines the centre of gravity will be high making them unstable when moved. Extreme care should be taken when moving any machine.
- If transportation of the machine is required then all precautions relating to the installation and handling of the machine apply. In addition, ensure that any vehicles or manual handling equipment used for transportation are of adequate specification.

6. The machine should be level and stable at all times

- When using a leg stand or cabinet base that is designed to be fitted to the machine, always ensure that it is securely fastened to the machine using the fixings provided.
- If the machine is suitable to be used on a workbench, ensure that the workbench is well constructed and capable of withstanding the weight of the machine. The machine should always be securely fastened to the workbench with appropriate fixings.
- Where possible, floor standing machines should always be secured to the floor with fixings appropriate to the structure of the floor.
- The floor surface should be sound and level. All of the feet of the machine should make contact with the floor surface. If they do not, either re-locate the machine to a more suitable position or use packing shims between the feet and the floor surface to ensure the machine is stable.

2. General Health & Safety Guidance cont.

7. Remove adjusting keys and wrenches

- Ensure that all adjusting wrenches and keys are removed before switching the machine 'ON'. There is a risk of severe personal injury or damage to the machine from airborne objects.

8. Before switching the machine 'ON'

- Clear the machine table of all objects (tools, scrap pieces etc.)
- Make sure there is no debris between the work piece and the table / work support.
- Ensure that the work piece is not pressed against, or touching the saw blade or cutting tool.
- Check all clamps, work holding devices and fences to ensure that they are secure and cannot move during machining operations.
- Plan the way that you will hold and feed the work piece for the entire machining operation.

9. Whilst machining

- Before starting work, watch the machine while it runs. If it makes an unfamiliar noise or vibrates excessively, switch the machine 'OFF' immediately and disconnect it from the power supply. Do not restart until finding and correcting the source of the problem.

10. Keep the work area clear

- Working clearances can be thought of as the distances between machines and obstacles that allow safe operation of every machine without limitation. Consider existing and anticipated machine needs, size of material to be processed through each machine and space for auxiliary stands and/or work tables. Also consider the relative position of each machine to one another for efficient material handling. Be sure to allow yourself sufficient room to safely operate your machines in any foreseeable operation.
- Cluttered work areas and benches create the risk of accidents. Keep benches clear and tidy away tools that are not in use.
- Ensure that the floor area is kept clean and clear of any dust and debris that may create trip or slip hazards.

11. Consider the work area environment

- Do not expose the machine to rain or damp conditions.
- Keep the work area well lit and ensure that there is artificial lighting available when there is insufficient natural light to effectively light the work area. Lighting should be bright enough to eliminate shadow and prevent eye strain.
- Do not use the machine in explosive environments eg. in the presence of flammable liquids, gases or dust.
- The presence of high levels of dust created by machining wood can present a risk of fire or explosion. Always use dust extraction equipment to minimise the risk.

12. Keep other persons away (and pets)

- The machine is designed to be used by one person only.
- Do not let persons, especially children, touch the machine or extension cable (if used) and keep visitors away from the work area.
- Never leave the machine running unattended. Turn the power supply off and do not leave the machine unattended until it comes to a complete stop.
- If the work area is to be left unattended, all machinery should be switched 'OFF' and isolated from the mains power supply.

13. Store machines safely when not in use

- When not in use, machines should be stored in a dry place, out of reach of children. Do not allow persons unfamiliar with these instructions or with the machine to operate it.

14. Do not overreach

- Choose a working position that allows your body to remain balanced and feed the work piece in to the machine without overreaching.
- Keep proper footing and balance at all times.

15. Electrical supply

- Electrical circuits should be dedicated to each machine or large enough to handle combined motor amp loads. Power outlets should be located near each machine so that power or extension cables are not obstructing high-traffic areas. Observe local electrical guidelines for proper installation of new lighting, power outlets, or circuits.
- The machine must be connected to an earthed power supply.
- The power supply must be equipped with a circuit breaker that provides short

circuit, overload and earth leakage protection.

- The voltage of the machine must correspond to the voltage of the mains power supply.
- The mains plug fitted to the machine should always match the power outlet. Do not modify the plug in any way. If a replacement plug is required it should be fitted by a competent person and of the correct type and rating for the machine.
- If you are unsure about any electrical connections always consult a qualified electrician.

16. Avoid unintentional starting of the machine

- Most machines are fitted with a no-volt release (NVR) switch to prevent unintentional starting. If in doubt always ensure the machine switch is in the 'OFF' position before connecting it to the power supply. This means the machine will not automatically start up after a power cut or switching on of the power supply, unless you first reset the start switch.

17. Outdoor use

- Your machine should not be used outdoors.

18. Extension cables

- Whenever possible, the use of extension cables is not recommended. If the use of an extension cable is unavoidable, then it should have a minimum core cross section of 2.5 mm² and limited to a maximum length of 3 metres.
- Extension cables should be routed away from the direct working area to prevent a trip hazard.

19. Guard against electric shock

- Avoid body contact with earthed or grounded surfaces such as pipes and radiators. There is an increased risk of electric shock if your body is earthed or grounded.

20. Always work within the machine's intended capacities

- Operator safety and machine performance are seriously adversely affected if attempts to make the machine perform beyond its limits are made.

21. Do not abuse the power cable

- Never pull the power cable to disconnect it from the power socket. Always use the plug.
- Keep the power cable away from heat, oil and sharp edges.
- Do not use the power cable for carrying or moving the machine.

22. Secure the work piece

- Ensure that the work piece is securely held before starting to machine it.
- When working within 300 mm of the machining area, always use a push stick to feed the work piece in to the blade or cutting tool. The push stick should have a minimum length of 400 mm. If the push stick becomes damaged, replace it immediately.
- Use extra supports (roller support stands etc.) for any work pieces large enough to tip when not held down to the table top.
- Do not use another person as a substitute for a table extension, or as additional support for a work piece that is longer or wider than the basic table, or to help feed, support, or pull the work piece.
- Do not attempt to machine more than one work piece at a time.
- When feeding the work piece towards the blade or cutting tool never position your hands in direct line of the cutting path. Avoid awkward operations and hand positions where a sudden slip could cause your hand or fingers to move into the machining area.

23. Stay alert

- Safety is a combination of operator common sense and alertness at all times when the machine is being used.
- Use all machines with extreme care and do not use the machine when you are tired or under the influence of drugs, alcohol or medication.

24. Use the correct tool for the job

- Do not use the machine for any purpose other than which it was designed.
- When selecting replacement cutting tools and blades, always ensure that they are designed to cut the material that you intend to use them for. If in any doubt seek further advice from the manufacturer.

25. Connect dust extraction equipment

- Always use dust extraction equipment. The dust extractor should be of suitable size and capacity for the machine that it is connected to and have a filtration level appropriate to the type of waste being collected. Refer to

2. General Health & Safety Guidance cont.

the relevant section of the manual for details of the specific dust extraction requirements for this machine.

- The dust extractor should be switched 'ON' before starting the machine that it is connected to. The dust extractor should be left running for 30 seconds after the last machining operation is complete in order to clear any residual waste from the machine.

26. Ensure that the machine is correctly guarded

- Never use the machine if any of the standard safety guards and equipment are removed or damaged.
- Some machines incorporate safety interlocks to prevent the machine from being used without the guards in place. Never attempt to bypass or modify the interlocks to allow the machine to be used without the guards in place.

27. Maintain your machine with care

- This manual gives clear instructions on installation, set up and operation of the machine and also details any routine and preventative maintenance that should be performed periodically by the user.
- Remember always to switch off and unplug the machine from the power supply before carrying out any setting up or maintenance operations.
- Follow any instructions for the maintenance of accessories and consumables.
- Do not use compressed air to clean the machine. Always use a brush to dislodge dust in places that are awkward to reach and a dust extractor to collect the waste.
- Inspect electric cables periodically and, if damaged, have them replaced by an authorised service facility or qualified electrician.
- Inspect extension cables (if used) periodically and replace if damaged.

28. Keep cutting tools sharp and clean

- Correctly maintained cutting tools are easier to control and less likely to bind.
- Cutting tools and blades can become hot during use. Take extreme care when handling them and always allow them to cool before changing, adjusting or sharpening them.

29. Disconnect the machine from the power supply

- When not in use, before servicing, changing blades etc. always disconnect the machine from the power supply.

30. Check for damaged parts

- Before each use of the machine, it should be carefully checked to determine that it will operate properly and perform its intended function.
- Check for alignment of moving parts, binding of moving parts, breakage of parts and any other conditions that may affect the operation of the machine.
- A guard or other part that is damaged should be properly repaired or replaced by a qualified person unless otherwise indicated in this instruction manual.
- Do not use the machine if the switch does not turn the machine 'ON' and 'OFF'.
- Have defective switches replaced by a qualified person.

31. Warning!

- The use of any accessory or attachment, other than those recommended in this instruction manual, or recommended by our Company may present a risk of personal injury or damage to the machine and invalidation of the warranty.

32. Have your machine repaired by a qualified person

- This machine complies with the relevant safety rules and standards appropriate to its type when used in accordance with these instructions and with all of the standard safety guards and equipment in place. Only qualified persons using original spare parts should carry out repairs. Failure to do this may result in considerable danger to the user and invalidation of warranty.

33. Caution! Motor may become hot during use

- It is normal for motors on some machines to become hot to the touch during use. Avoid touching the motor directly when in use.

3. Additional Health & Safety for Dust Extractors

1. Safe Operation

- Floor standing dust extractors should be positioned on a level floor. Ensure that there is no debris between the base of the extractor and the floor.
- Wall mounted dust extractors, or those used with an optional wall mounting bracket, should be fixed to a solid block or brick wall using suitable fixings that will withstand the weight of the machine. If fixing to a studded wall, care should be taken to locate the fixings in to the studding of the wall. Plasterboard alone is not strong enough to withstand the weight of the machine.
- When wall mounting the dust extractor always consider it's gross weight when full of waste in order to select the correct type of fixings.
- Never place the dust extractor on a raised surface or workbench.
- In all cases, position the dust extractor as close as possible to the application it is to be used for.
- It may be necessary to increase the length or reduce the diameter of the extraction hose to suit the application. Never over stretch the hose to make it reach.
- The strength of suction alone may cause the dust extractor to be pulled in the direction of the hose, particularly if the hose has been over stretched or if an optional wheel kit is fitted. Never stand directly between the dust extractor and the machine that it is connected to.

2. Familiarise yourself with the machine

- If you are not thoroughly familiar with dust extractors, be aware of the inherent risks due to the way in which these machines work. There are moving parts inside the machine that can cause serious injury. Always strictly follow any safety instructions detailed in the manual when using, emptying or servicing the machine.

3. Before switching the machine 'ON':

- Remove the transit strap, which is used to secure the lid assembly to the drum body, before use. Never use the machine with this strap fitted as it is designed purely to protect the machine during transit.
- Ensure that the switch of the machine is in the 'OFF' position before connecting or disconnecting the power supply.
- Ensure that the extraction hose is securely fitted to the outlet of the dust extractor.
- Always ensure that the cartridge and paper filter are securely and correctly positioned before using the dust extractor. Failure to do so will result in dust being sucked into the motor. Always ensure a good seal between the filter and motor enclosure.
- Check that the drum filter is in place (certain models only) before replacing the lid of the machine.
- Check that the dust collection bag (certain models only) is secure and not damaged. If damaged, replace the collection bag before starting the machine.

4. Whilst using the dust extractor:

- Do not completely cover the end of the extraction hose as the machine may be pulled in the direction of the hose.
- Do not attempt to remove the lid assembly from the drum body.
- Do not attempt to use the dust extractor without the extraction hose fitted to the inlet on the drum body.
- This product is for dry use only and should not be used or stored outdoors or in wet conditions.

- All Record Power dust extractors are designed solely for use with wood dust and chippings. Do not use the machine to remove vapours, fumes, gases or other materials such as plaster dust, as there is a risk of combustion. Doing so will invalidate the warranty and may result in damage to the machine or serious injury to the user.
- Do not use the machine to pick up hazardous dust.
- If the hose becomes blocked, switch the machine 'OFF' immediately to prevent any damage to the machine and disconnect from the power supply before removing the blockage. Never attempt to place your hand inside the hose or inlet of the dust extractor whilst it is running.
- Do not pick up liquids and scrap metal (such as nails and filings) or any combustible substance.
- Ensure that the machine is used in a well ventilated area.

5. Avoiding fires:

- Wood dust is combustible and when suspended in the air, it may form a cloud which can explode if the air concentration is higher than 40g/m³.
- Sparks can smolder in dust for a long time before fire or flame is detected. If metal contacts metal during operation, immediately switch the machine 'OFF', disconnect the power cable from the mains supply and wait for the motor to come to a complete stop. Empty the dust into an approved air tight metal container in case of spark. Remedy the metal to metal contact problem before resuming operation.
- Do not operate the dust extractor in environments containing explosive risks, such as pilot lights, open flames, vapours, gases or high levels of airborne dust.

6. Maintenance:

- Always switch the machine 'OFF', disconnect from the power supply and wait until the motor has completely stopped before carrying out any routine maintenance such as emptying waste or replacing filters.
- When replacing the filters, keep your hands away from the fan blade within the motor.
- A paper filter must always be fitted to the cartridge filter as this filters particles as small as 0.5 microns and provides protection from fine dust which is most hazardous to health.
- Do not switch the head unit 'ON' unless it is attached to the collection drum or body unit. The centrifugal force created by the motor will cause the head to rotate very quickly and can cause serious personal injury.
- If the machine becomes hot during use this means the filters are blocked and need to be cleaned. Any damage to the machine caused by blocked filters will not be covered under warranty.

7. The elimination or control of risks from wood dust is required by the 'Health & Safety at Work etc. Act 1974', the 'Provision & Use of Work Equipment Regulations 1998' and the 'Control of Substances Hazardous to Health (COSHH) Regulations 2002'. We recommend that you study and follow these regulations.

Further guidance can be obtained from The Health & Safety Executive and their website www.hse.gov.uk.

4. Record Power Guarantee

“**Products**” means the Products sold by Record Power subject to these terms and conditions;

“**Record Power**” is Record Power Limited, whose company registration number is 4804158 and registered office address is Centenary House, 11 Midland Way, Barlborough Links, Chesterfield, Derbyshire, S43 4XA and sells through a network of Authorised Dealers;

“**Authorised Distributor**” is the nominated importer for your region who will generally sell through a network of Authorised Dealers. Details of Authorised Distributors for specific countries can be found in the Product manual or at www.recordpower.info;

“**Authorised Dealer**” is a retailer or business authorised to sell Record Power Products to end users.

1 Guarantee

- 1.1 Record Power guarantees that for a period of 5 years from the date of purchase the components of qualifying Products (see clauses 1.2.1 to 1.2.9) will be free from defects caused by faulty construction or manufacture.
- 1.2 During this period Record Power, its Authorised Distributor or Authorised Dealer will repair or replace free of charge any parts which are proved to be faulty in accordance with paragraphs 1.1 above provided that:
 - 1.2.1 you follow the claims procedure set out in clause 2 below;
 - 1.2.2 Record Power, our Authorised Distributor or Authorised Dealer are given a reasonable opportunity after receiving notice of the claim to examine the Product;
 - 1.2.3 if asked to do so by Record Power, its Authorised Distributor or Authorised Dealer, you return the Product, at your own cost, to Record Power’s premises or other approved premises such as those of the Authorised Distributor or supplying Authorised Dealer, for the examination to take place;
 - 1.2.4 the fault in question is not caused by industrial use, accidental damage, fair wear and tear, wilful damage, neglect, incorrect electrical connection, abnormal working conditions, failure to follow our instructions, misuse, or alteration or repair of the Product without our approval;
 - 1.2.5 the Product has been used in a domestic environment only;
 - 1.2.6 the fault does not relate to consumable Products such as blades, bearings, drive belts or other wearing parts which can reasonably be expected to wear at different rates depending on usage (for full details contact Record Power or your local Authorised Distributor);
 - 1.2.7 the Product has not been used for hire purposes, by you or by a previous owner;
 - 1.2.8 the Product has been purchased by you as the guarantee is not transferable from a private sale.
 - 1.2.9 where the Product has been purchased from a retailer, the 5 year guarantee is transferable and begins on the date of the first purchase of the Product and in the event of a claim under this guarantee proof of the original purchase date will be required to validate the warranty period.

2 Claims Procedure

- 2.1 In the first instance please contact the Authorised Dealer who supplied the Product to you. In our experience many initial problems with machines that are thought to be due to faulty parts are actually solved by correct setting up or adjustment of the machines. A good Authorised Dealer should be able to resolve the majority of these issues much more quickly than processing a claim under the guarantee.
- 2.2 Any damage to the Product resulting in a potential claim under the guarantee must be reported to the Authorised Dealer from which it was purchased within 48 hours of receipt.
- 2.3 If the Authorised Dealer who supplied the Product to you has been unable to satisfy your query, any claim made under this Guarantee should be made directly to Record Power or its Authorised Distributor (for details of the Authorised Distributor in your country please see your Product manual or check www.recordpower.info for details). The claim itself should be made in a letter setting out the date and place of

purchase, and giving a brief explanation of the problem which has led to the claim. This letter should then be sent with proof of the purchase date (preferably a receipt) to Record Power or its Authorised Distributor. If you include a phone number or email address this will help to speed up your claim.

- 2.4 Please note that it is essential that the letter of claim reaches Record Power or its Authorised Distributor on the last day of this Guarantee at the latest. Late claims will not be considered.

3 Limitation of Liability

- 3.1 We only supply Products for domestic and private use. You agree not to use the Product for any commercial, business or re-sale purposes and we have no liability to you for any loss of profit, loss of business, business interruption or loss of business opportunity.
- 3.2 This Guarantee does not confer any rights other than those expressly set out above and does not cover any claims for consequential loss or damage. This Guarantee is offered as an extra benefit and does not affect your statutory rights as a consumer.

4 Notice

This Guarantee applies to all Products purchased from an Authorised Dealer of Record Power within the United Kingdom of Great Britain and Northern Ireland. Terms of Guarantee may vary in other countries – please check with the Authorised Distributor in your country (details of the Authorised Distributor for your country can be found in the manual or at www.recordpower.info).

5. Specifications

Filtration:	0.5 Micron
Capacity:	45 litres
Weight:	11 kg
Air Flow:	53 litres / second
Motor:	1 kW
Size:	H620 x W530 x D360 mm
Sound Pressure:	LPA < 75 dB (A)
Sound Power:	LWA < 85 dB (A)

6. Contents of the Package

Inside the shipping container you will find the following:

1. Motor cover and switch unit
2. Main body with pre-installed hose connector
3. Handle
4. Socket head cup screw x2
5. Jubilee clip x2
6. Motor unit including pre-installed filter bag
7. Transit strap
8. Spare filter bag
9. 2 M of 100mm Diameter hose

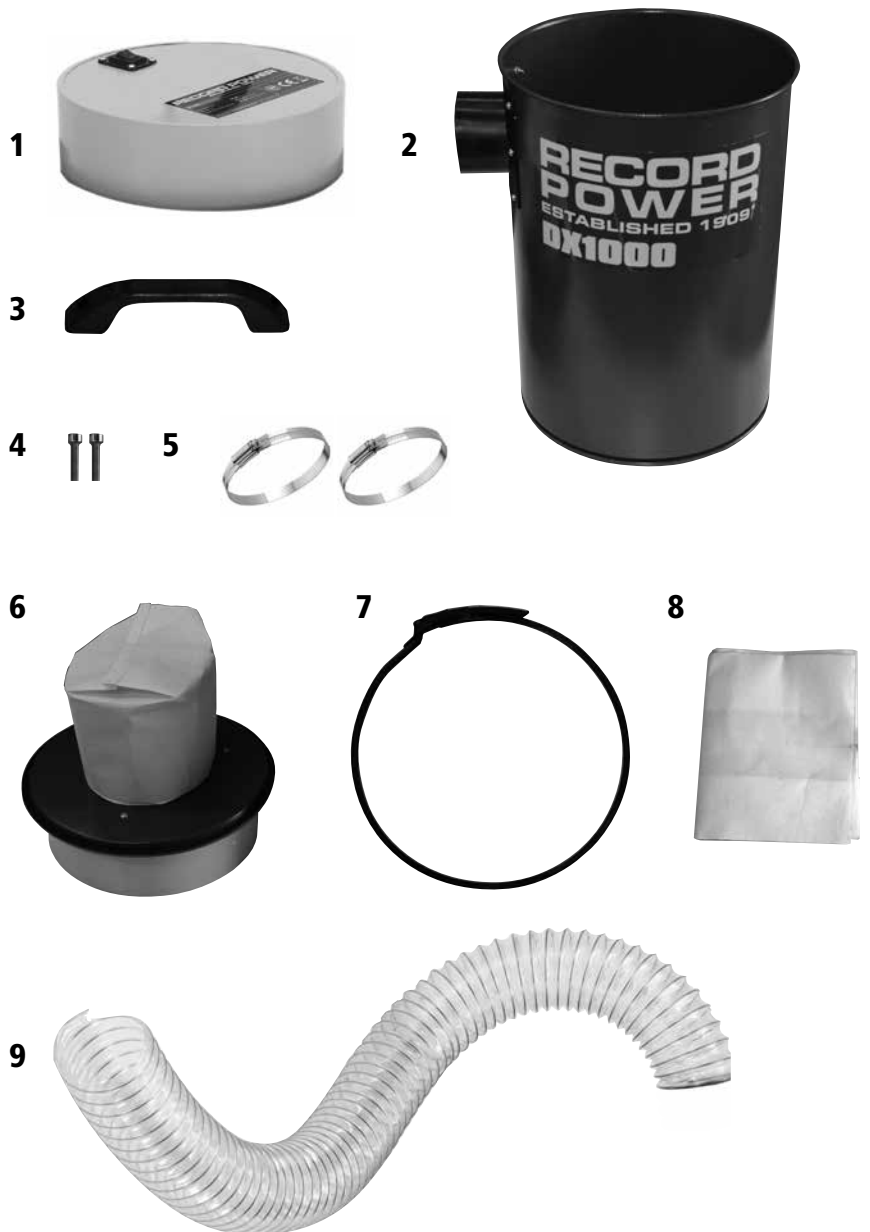

7. Assembly & Operation

1. Attach one end of the flexible hose to the machine inlet and secure with the jubilee clip supplied (**Fig 7.1**).
2. Place the cartridge filter with open end uppermost inside a paper filter-bag and fold the top edges of the paper bag down inside the cartridge (**Fig 7.2**).
3. Push this on to the motor body, making sure that it is securely positioned (**Fig 7.3**).
3. Position the hood unit on the machine body.
4. Screw the handle to the lid cover using the two screws supplied (**Fig 7.4**).

The dust extractor is now ready for use.

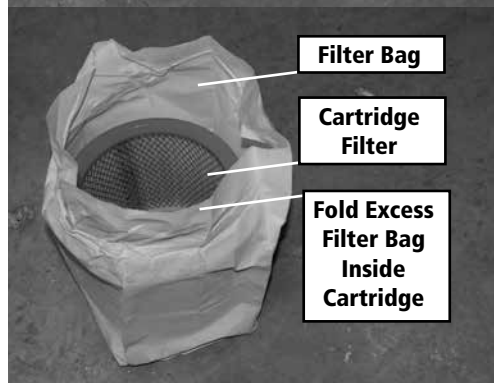
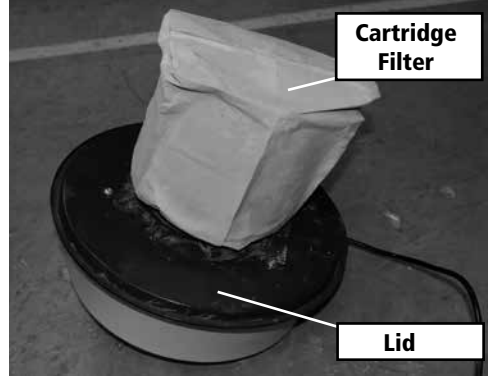
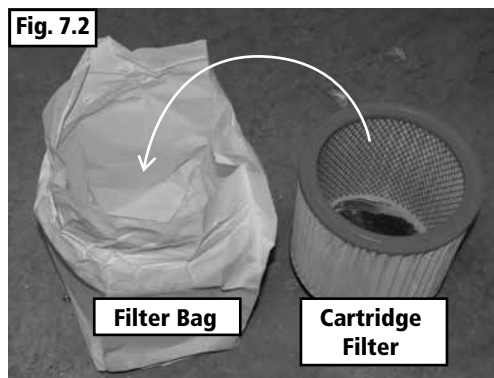
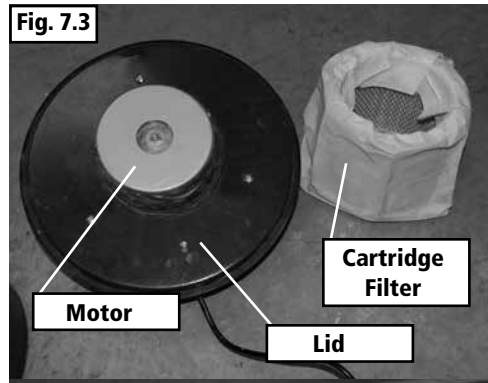
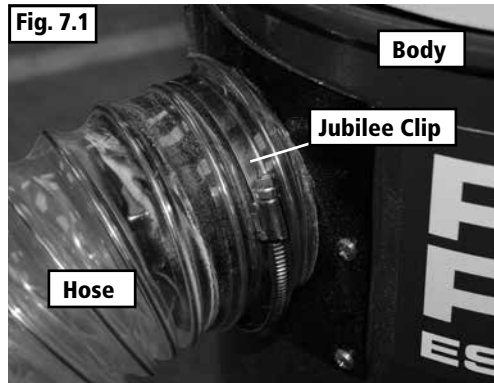

IMPORTANT

Always ensure that the end of the 102mm diameter flexible hose is not completely covered or blocked or the machine may be 'pulled' suddenly towards the end of the hose.

Completely covering or blocking the flexible hose will restrict airflow to the motor and may result in overheating and damage to the motor. In addition, the increased pressure within the body of the machine may cause the body to distort or implode.

The 100 mm diameter flexible hose is intended mainly for connection to woodworking machinery to collect sawdust and shavings.

For cleaning purposes we recommend the use of the optional DX1500B 100-32mm Reducer 2m 32mm Hose for HPLV Extractors

Restarting

In the Event of a Blockage

If a blockage in the collection hose of the machine occurs, switch it off immediately by pressing the power switch to the off position and wait for the machine to come to a complete stop before proceeding further.

Unplug the machine from the power source and remove the blockage from the collection hose. To re-start the machine press the power switch to the on position.

In the Event of a Power Failure

In the event of a power failure, first turn the power switch to the off position and then locate and rectify the source of the failure. If the fault is within the power circuit of the workshop, there may be an underlying cause (circuit overload etc.) that should be investigated by a qualified electrician, before attempting to restore the power source.

Once the power is restored, the machine can be re-started by pressing the switch to the on position.

8. Electrical Connection & Wiring Diagram

Machines supplied for use in the UK are fitted with a 3 pin plug conforming to BS1363, fitted with a fuse conforming to BS1362 and appropriate to the current rating of the machine.

Machines supplied for use in other countries within the European Union are fitted with a 2 pin Schuko plug conforming to CEE 7/7.

Machines supplied for use in Australia & New Zealand are fitted with a 3 pin plug conforming to AS/NZS3112.

In all cases, if the original plug or connector has to be replaced for any reason, the wires within the mains power cable are colour coded as follows:

230 V (Single Phase)

Brown: Live (L)
Blue: Neutral (N)
Green and Yellow: Earth (E)

The wire coloured brown must always be connected to the terminal marked 'L' or coloured red.

The wire coloured blue must always be connected to the terminal marked 'N' or coloured black.

The wire coloured green and yellow must always be connected to the terminal marked 'E' or with the earth symbol:



or coloured green / green and yellow.

It is important that the machine is effectively earthed. Some machines will be clearly marked with the double insulated logo:



In this case there will not be an earth wire within the circuit.

In the case of the BS1363 plug for use in the UK, always ensure that it is fitted with a fuse conforming to BS1362 appropriate to the rating of the machine. If replacing the original fuse, always fit a fuse of equivalent rating to the original.

Never fit a fuse of a higher rating than the original. Never modify the fuse or fuse holder to accept fuses of a different type or size.

Where the current rating of the machine exceeds 13 A at 230 V, or if the machine is designated for use on a 400 V 3 phase supply a connector conforming to BS4343 (CEE17 / IEC60309) will be used.

230 V machines will be fitted with a blue 3 pin connector. The wiring for this type of this connector will be the same as shown above.

400 V, 3 phase machines will be fitted with a red 4 or 5 pin connector. The wiring for this type of connector is as shown below:

400 V (3 phase)

Brown: Live (L1)
Black: Live (L2)
Grey: Live (L3)
Blue: Neutral (N)
Green and Yellow: Earth (E)

The wire coloured brown must always be connected to the terminal marked 'L1'.

The wire coloured black must always be fitted to the terminal marked 'L2'.

The wire coloured grey must always be connected to the terminal marked 'L3'.

The wire coloured blue must always be connected to the terminal marked 'N' or coloured black.

The wire coloured green and yellow must always be connected to the terminal marked 'E' or with the earth symbol

If in doubt about the connection of the electrical supply, always consult a qualified electrician.

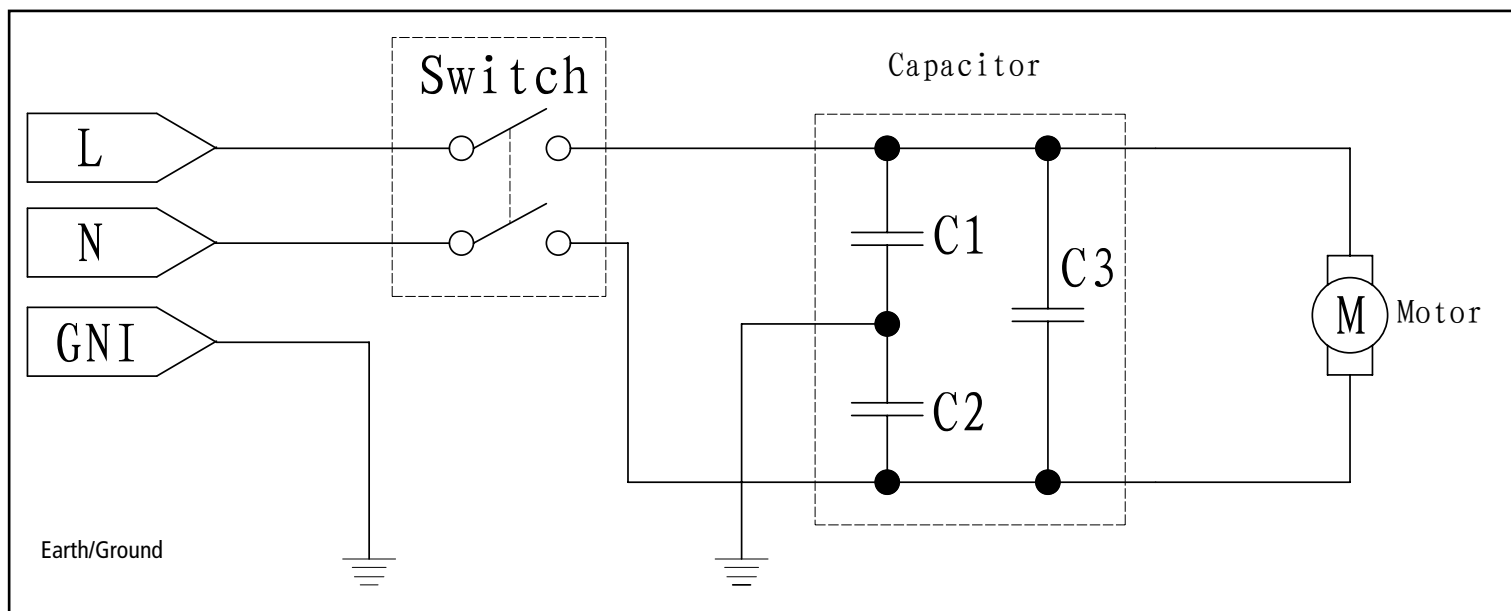

9. Dust Extraction

The Importance Of Dust Extraction

Before the machine is started, ensure that adequate dust extraction provisions have been installed. Dust extraction is extremely important not only for health and safety but also for the correct upkeep of the machine. Saw dust can cause the machine not to operate properly or even fail completely. By keeping the machine free of large amounts of waste the performance will be optimised.

If a large amounts of MDF or toxic woods are to be cut we recommend that there is a good ventilation system in place and that in addition to proper extraction a mask or respirator be worn as minimum protection.

Record Power Extractors

Record Power offer a range of high quality dust extractors, we offer both drum and bag type extractors which filter down 0.5 micron providing protection from harmful fine dusts. All Record Power dust extractors & chip collectors have 100 mm inlets and hoses.

DX1000 High Filtration Dust Extractor

Drum type extractor, 45 litre capacity, single 1 kW motor, suitable for intermittent use ie must be switched off for 20 minutes every hour.

0.5 micron filtration

RSDE1 High Filtration Dust Extractor

Drum type extractor, 45 litre capacity, single 1 kW motor, suitable for intermittent use ie must be switched off for 20 minutes every hour.

0.5 micron filtration

RSDE2 High Filtration Dust Extractor

Drum type extractor, 50 litre capacity, single 1 kW motor, suitable for intermittent use ie must be switched off for 20 minutes every hour.

0.5 micron filtration

RSDE/2A High Filtration Dust Extractor with Auto Switching

Drum type extractor, 50 litre capacity, single 1 kW motor, auto switching allows the machine to be turned on and off as machines and power tools are operated. Suitable for intermittent use ie must be switched off for 20 minutes every hour. Maximum auto switch capacity tools up to 1.1 kW.

0.5 micron filtration

DX4000 High Filtration Dust Extractor

Drum type extractor, 80 litre capacity, Twin 1 kW motor, suitable for heavy usage ie if one motor is switched off for 20 minutes then the other can be used thus enabling continuous usage. Or both motors can be used simultaneously giving maximum suction but in this mode the extractor must be switched off for 20 minutes every hour. **0.5 micron filtration**

DX5000 High Filtration Dust Extractor

Bag type extractor, 200 litre capacity, Twin 1 kW motor, suitable for heavy usage ie if one motor is switched off for 20 minutes then the other can be used thus enabling continuous usage. Or both motors can be used simultaneously giving maximum suction but in this mode the extractor must be switched off for 20 minutes every hour. **0.5 micron filtration**

CX2000 Compact Chip Extractor

Medium capacity chip collector, with a powerful 0.56 kW induction motor. An extremely smooth running unit suitable for continuous usage. Very quiet impeller system extracts dust and chippings.

CX2600 Chip Collector

Large capacity chip collector, with a powerful 0.37 kW induction motor. An extremely smooth running unit suitable for continuous usage. Very quiet impeller system extracts dust and chippings.

Suitable for chip collection or finer dust using the optional filter cartridge

CX3000 Chip Collector

Larger capacity chip collector, with a more powerful 0.75 kW induction motor and heavy duty construction. An extremely smooth running unit suitable for continuous usage. Very quiet impeller system extracts dust and chippings.

Suitable for chip collection or finer dust using the optional filter cartridge

Air Cleaners

It is strongly advised to also use an air cleaner to remove the fine airborne dust present in the workshop which cannot be removed using machine extraction. Record Power offer a range of air cleaners suitable for all home workshops. Please contact your preferred stockist or visit www.recordpower.info.

	DX1000	RSDE1	RSDE2	RSDE/2A	DX4000	DX5000	CX2000	CX2600	CX3000
Bandsaws Circular saws Sanders Intermittent usage	✓ Recommended	✓ Recommended	✓ Recommended	✓ Recommended	✓ Recommended	✓ Recommended			
Bandsaws Circular saws Sanders Heavy usage					✓ Recommended	✓ Recommended			
Planer Thicknessers Spindle Moulders Universals Intermittent usage	✓ Recommended	✓ Recommended			✓ Can be used	✓ Recommended	✓ Recommended	✓ Recommended	✓ Recommended
Planer Thicknessers Spindle Moulders Universals Heavy usage					✓ Can be used	✓ Recommended		✓ Recommended	✓ Recommended
Dust Extraction System Intermittent usage					✓ Can be used	✓ Recommended			

10. Maintenance



WARNING: Before any type of maintenance is carried out, it is important that the machine is switched off and disconnected from the power supply.

Replacing the Filters

The filters should be inspected every time the unit is emptied and particularly if any reduction in performance is noted.

The paper filters trap fine dust, and to prevent becoming clogged should be renewed regularly (part no. DX1500E).

The cartridge filter should be cleaned at the same time, and should be renewed annually or immediately if showing signs of damage or wear (part no. DX1500F).

To Change the filters:

1. Remove the hood unit (**Fig 10.1**).
2. The cartridge filter is contained within the paper filter bag (**Fig 10.2**), it can be removed by unfolding and carefully lifting out.

NOTE: Care should be taken when handling soiled or contaminated filter bags and cartridges. As certain fine dusts can be harmful. Always wear suitable PPE for additional protection.

3. The paper bag can be removed from around the cartridge filter and disposed of.
4. The cartridge filter can then be carefully cleaned with a vacuum cleaner, or renewed if required.
5. Place the cartridge filter inside a new paper filter bag and fold the top edges of the of the paper filter bag down inside the cartridge, noting not to fold the edges any more than **50mm inside the cartridge filter**. Following instructions from the 'Operations and Assembly' Section of this manual
6. Replace the filters into the machine by pressing them back into position.
7. Replace the hood unit.

Renewing Motor brushes

The motor carbon brushes should not need replacing for at least 2000 hours. These are contained within the horizontal housings on top of the motor, and once removed from the housings, cannot be reinserted.

1. To fit new carbon brushes, first ensure the machine is switched off and disconnected from the power supply.
2. Remove the lid cover from the head of the machine by unscrewing the three cross head screws holding it in place, to gain access to the top of the motor (**Fig 10.3**).
3. Remove the brush carrier from the motor by unscrewing the two screws that secure it (**Fig 10.4**).
4. Push in the location tab, remove the spade terminal connector and slide the brush housing out of the carrier (**Fig 10.5**).
5. Replace brush and brush housing with new ones and follow these steps in reverse to attach back onto the motor.

NOTE: When replacing motor brushes, take care not to allow dust, oil, water etc. to get into the motor.

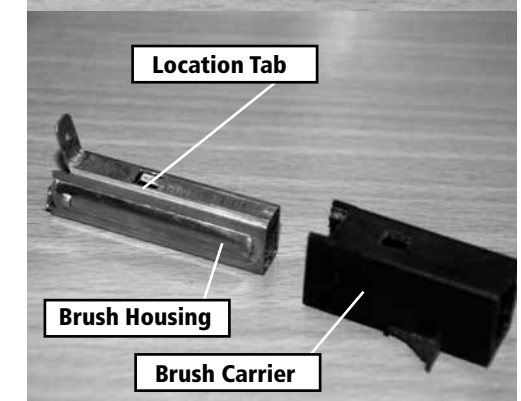
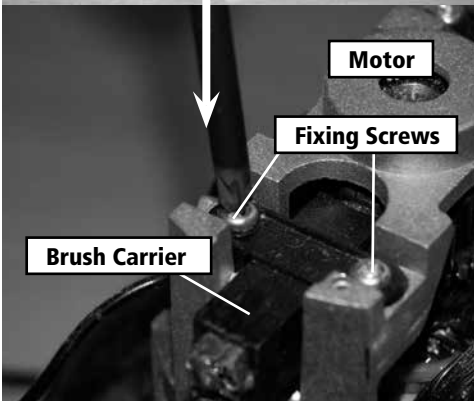
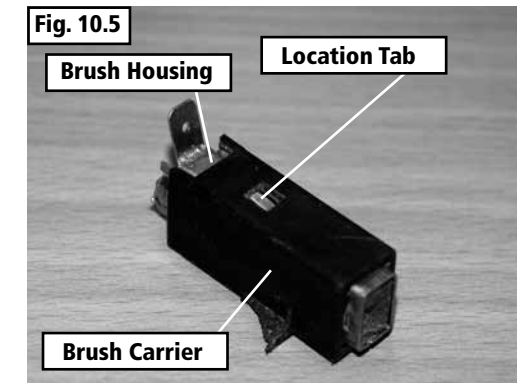
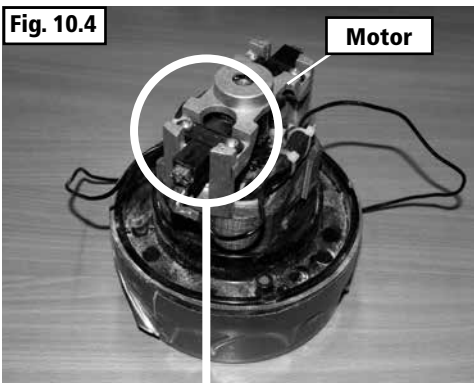
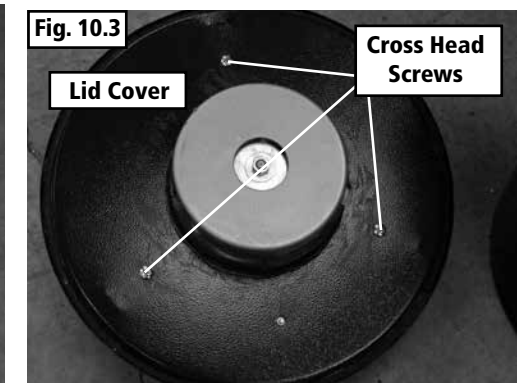
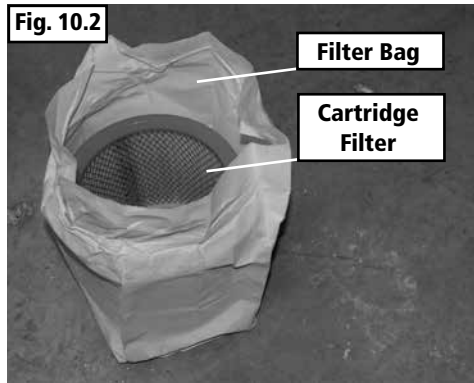
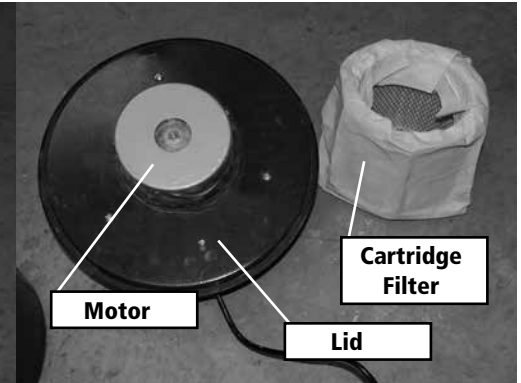
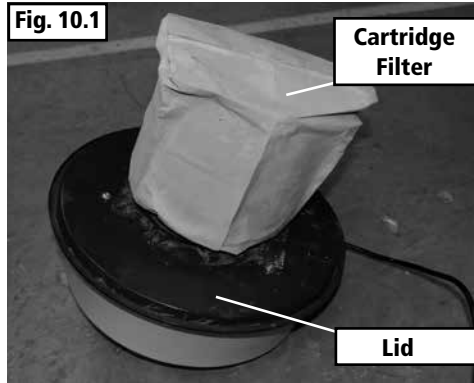

11. Parts Diagram & List

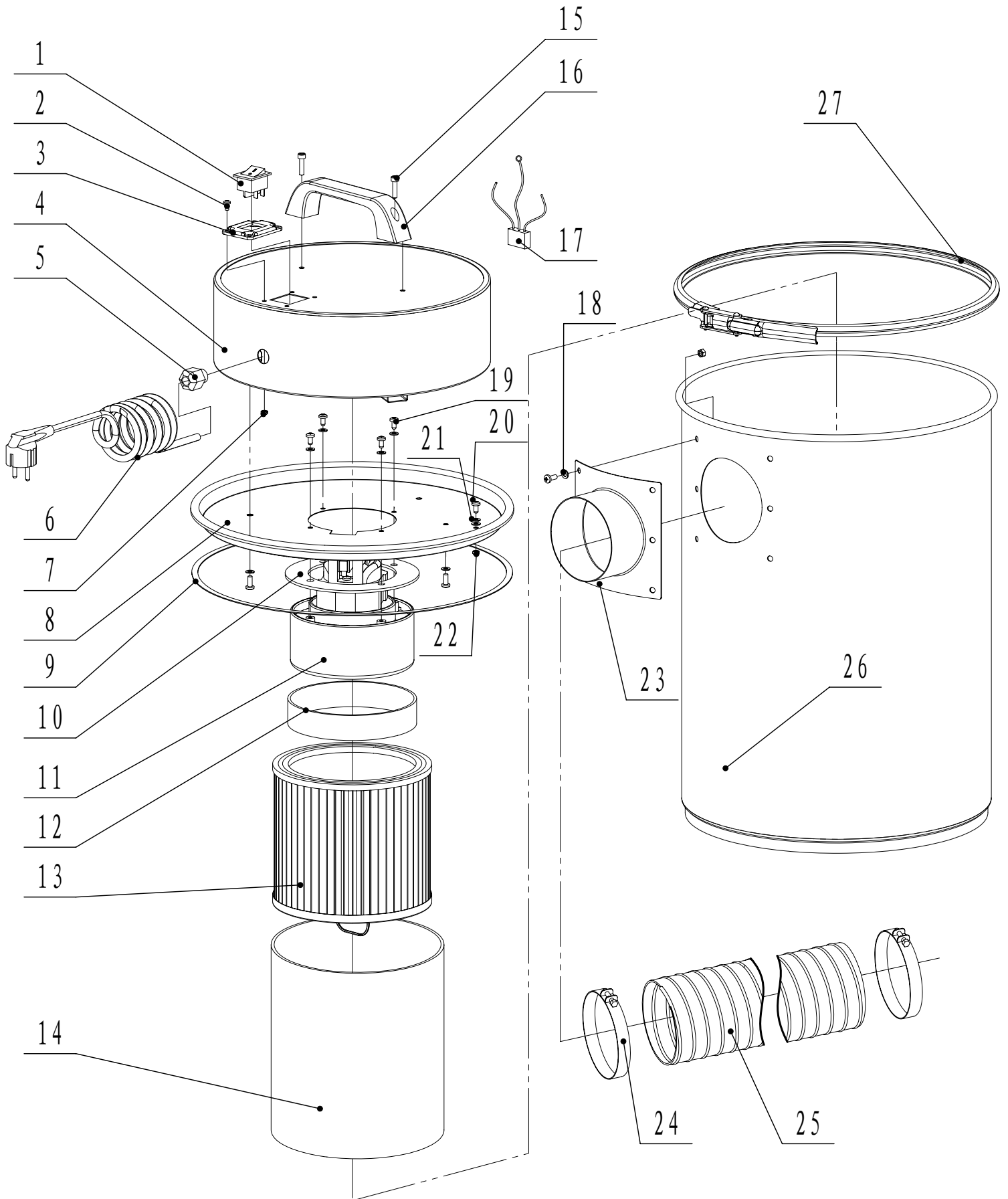

11. Parts Diagram & List - Cont.

No.	Description	Ref. Number	Quantity
1	switch	KND2-12/2-250V	1
2	pan head screw	M4X10 GB/T818-2000	4
3	switch mount plate	JMDE0201011101	1
4	lid cover	JMDE0201011000	1
5	M16 strain release	JL91046300	1
6	power cord	2-B43102200-483	1
7	I type hex nut M4	GB/T6170-2000	4
8	lid	JMDE0201014000	1
9	packing washer	JMDE0201040004	1
10	motor packing washer	JMDE0201040001	1
11	motor	HDWX-1000F	1
12	cartridge packing washer	JMDE0201040003	1
13	filter cartridge (DX1500F)	JMDE0201031000	1
14	filter bag (DX1500E)	JMDE0201032001	1
15	hex head screw	M5x25 GB/T70.1-2000	2
16	handle	JL70013003	1
17	capacitor/supressor	TNS-3TH/0.22uf+2x4700pf	1
18	flat washer	GB/T97.1-1985	14
19	pan head self tapping screw	ST4.8XG2B2/ZTF845-2000	4
20	pan head screw	M5X12 GB/T818-2000	10
21	motor assm. (Earth connector)	GB/T93-1987	1
22	I type hex nut	M5 GB/T6170-2000	1
23	extraction port	JMDE0201012101	1
24	clip assembly (Jubilee)	JMDE0201013000	2
25	extraction hose	JMDE0201130001	1
26	main body	JMDE0201012000	1
27	transit strap	JMDE0201013000	1

EU Declaration Of Conformity

Cert No: EU / DX1000 / 1

RECORD POWER LIMITED,

Centenary House,
11 Midland Way,
Barlborough Links,
Chesterfield, Derbyshire S43 4XA
declares that the machinery described:-

1. Type: **High Filtration Dust Extractor**
2. Model No: **DX1000**
3. Serial No



Conforms with the following directives:-

MACHINERY DIRECTIVE	2006/42/EC EN ISO 12100-2/A1:2009 EN60335-2-69:2009
LOW VOLTAGE DIRECTIVE and its subsequent amendment	2004/108/EC EN55014-1/A1:2009 EN55014-2/A2:2008 EN61000-3-2/A2:2009 EN61000-3-11:2000 EN61000-3-3:2008
ELECTROMAGNETIC COMPATIBILITY DIRECTIVE and its subsequent amendments	2006/95/EC EN 55014-1:2006 EN ISO 12100-2/A1:2009 EN60335-2-69:2009

CERTIFICATE NUMBERS: M8A110476419004, N8M110476419005, E8N110276419001, E8N1102576419002

and conforms to the machinery example for which the
EC Type-Examination Certificate No.
has been issued by **TUV Rheinland Product Safety GmbH**,
at: Am Grauen Stein, D-51105. Cologne, Germany

and complies with the relevant essential health and safety requirements.

Signed..... Dated: 01/05/2011

Andrew Greensted
Managing Director



Over
100
 years
 Experience • Knowledge
 Support • Expertise

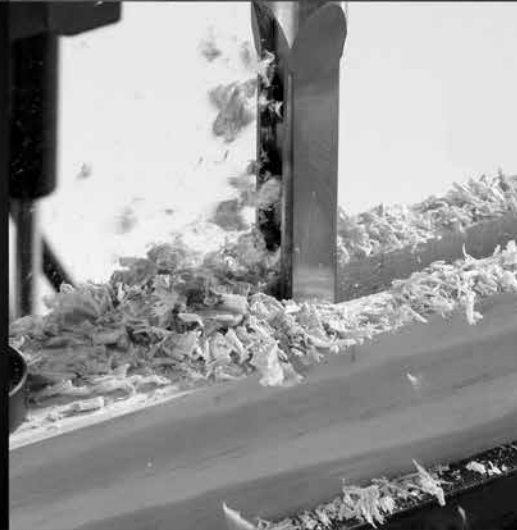

RECORD POWER
 ESTABLISHED 1909®

Woodworking Machinery & Accessories

United Kingdom

Record Power Ltd

Centenary House, 11 Midland Way
 Barlborough Links, Chesterfield
 Derbyshire S43 4XA
 Telephone: 01246 571 020
 www.recordpower.co.uk

Eire

Record Power Ltd

Centenary House, 11 Midland Way
 Barlborough Links, Chesterfield
 Derbyshire S43 4XA
 Telephone: 01246 571 020
 www.recordpower.co.uk

Australia

Tools 4 Industry

Po Box 3844
 Parramatta 2124
 Tel: 1300 124 422
 Fax: 1800 262 725
 www.recordpower.com.au

New Zealand

Tools 4 Industry

Po Box 276079
 Manukau City 2241
 Tel: 0800 142 326
 Fax: 09 2717 237
 www.recordpower.co.nz